

**Technical Specifications**

**General**

ID	: 4516
System Wattage	: 30W LED
Driver Integral	: Constant Current
Input Voltage	: 230-240Vac
Frequency	: 50-60 Hz
Operating Voltage	: 100-277Vac
Operating Temperature	: -15°C~+50°C

**Physical**

Body	: Spun aluminium top cover & Die cast aluminium base
Diffuser	: Clear acrylic / Clear PC
Mounting	: Suitable for Ø50mm OD Pipe
Finish	: Powder Coated Graphite Grey / Jet Black Anthracite Grey

**Light Source**

Light Source	: OSRAM / LUMILED
LED Lumens	: 4425 lm
CRI (Ra)	: >80
LED Colour Temperature	: 3000K / 4000K / 5700K

**Driver**

Power Supply	: Integral
Power Factor	: >0.95
THD	: <10%
Surge Protection	: 4KV
Efficiency	: >85%

**Optical Performance**

Colour Temperature	: 3000K / 4000K / 5700K
Luminous flux	: 3638 / 3664 / 3700 lm
Light Distribution	: Type IV

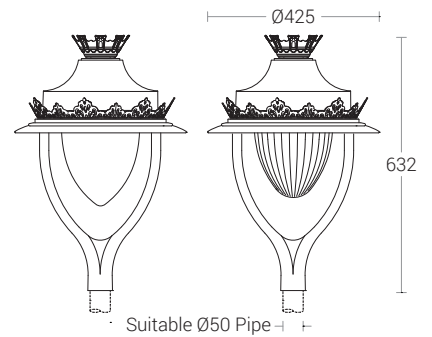

**Photometric Data**

