

## NAVITA

### Powerful Light Powerful Design

High efficiency LED flood lights are engineered to deliver powerful, directional spot illumination with exceptional performance. Designed with advanced optical technology, these luminaires offer high luminous efficacy, uniform light distribution, and an extended service life, ensuring consistent illumination over time.

High efficiency LED flood lights designed to provide directional spot light. The product design and construction of the luminaires are characterized by high luminous efficiency, an extremely long service life and uniform illuminance. Their sturdy construction makes them particularly suitable for areas where a high level of robustness is required.

### Product Description

- Luminaire made of pressure die cast aluminium of high corrosion resistance and external non corrosive stainless steel fasteners.
- Clear tempered glass.
- Bracket to facilitate proper aiming of the luminaire at desired angle.
- Available Beam Angles 15° / 25°/ 40° (8° / 10°x60° - On Request).
- Cable entries for through-wiring of mains supply cable.
- CRI (Ra) : >80 (90 CRI - On Request)
- Prewired with LED driver and suitable for operating on 240V, 50Hz single phase ac supply.
- Available CCT : 3000K (Other CCT's On Request)



### Product Benefits

- High luminous efficiency at reduced wattage.
- Elegant, Robust design
- Sustainable LED technology offers durability and optimal light output with low power consumption.

### Area of Application

Architectural and building facade lighting, Pathways, Parks, Sculptures, Structures and Security lighting.

### Available Finish

- Pure polyester powder coated
- RAL 9005 Jet black

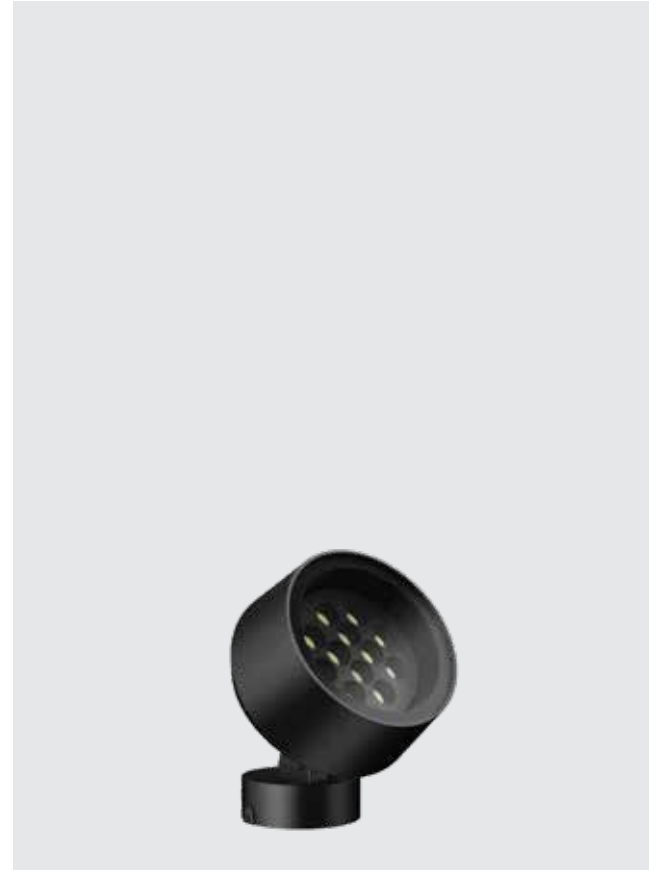

**Note :** It is our constant endeavor to upgrade the performance of our products. For the latest technical information, IES files and product updates please refer to the website at [www.klite.in](http://www.klite.in)

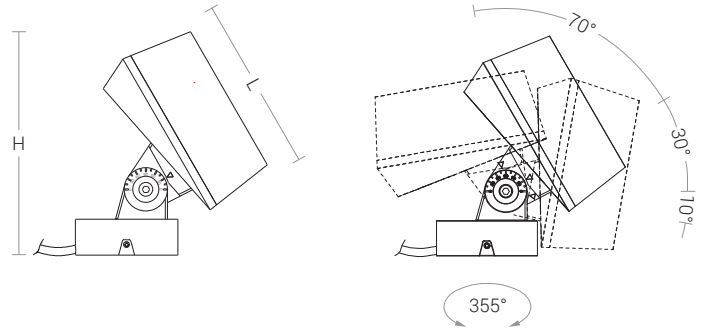

Product Name	NAVITA MINI	NAVITA MIDI	NAVITA MAXI	NAVITA MEGA
Product Code	KL-22580	KL-22582	KL-22583	KL-22579
Input Wattage	15W	30W	60W	72W
Dimension (L x H)	Ø130 x 177	Ø170 x 218	Ø210 x 258	Ø260 x 310
Color Temperature	3000K (Other CCT's On Request)			
Beam Angle	15° / 25° / 40° (8° / 10°x60° - On Request)			
Input Voltage	230-240Vac			
Frequency Range	50/60Hz			
Surge Protection	3KV			
Color rendering index	Ra>80 (90 CRI - On Request)			
Operating Temperature	-20°C~+40°C			
Protectin Grade	IP66			
Protection level	IK05			
Diffuser	Clear Tempered Glass			
Finish	Powder Coated RAL 9005 Jet Black			

**NAVITA MINI**

ID : 22580 - 15W

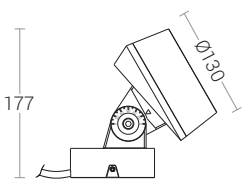

**NAVITA MIDI**

ID : 22582 - 30W

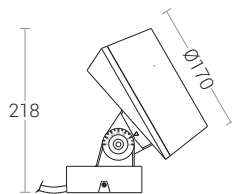

**NAVITA MAXI**

ID : 22583 - 60W

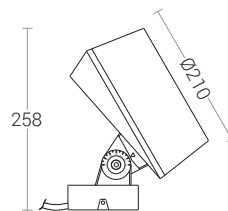

**NAVITA MEGA**

ID : 22579 - 72W

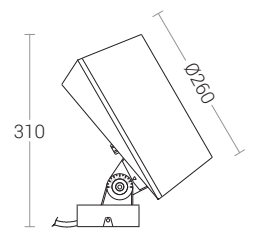

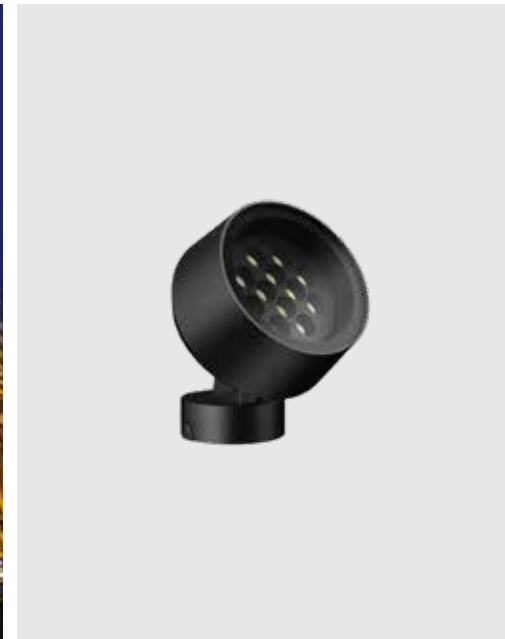

OPEN SOURCE

**Technical Specifications**

**General**

System Wattage : 15W/30W/60W/72W  
 Operating Temperature : -20°C~+40°C

**Physical**

Body : Die cast aluminium  
 Diffuser : Clear Tempered Glass  
 Mounting : Surface  
 Finish : Powder Coated  
 RAL 9005 Jet black

**Light Source**

Light Source : OSRAM / CREE  
 CRI (Ra) : >80 (90 CRI - On Request)  
 LED Colour Temperature : 3000K (Other CCT's On Request)

**Driver**

Power Supply : Integral  
 Input Voltage : 230-240Vac  
 Frequency : 50-60Hz  
 Surge Protection : 3KV  
 Efficiency : >85%  
 Dimmable Option : DALI

**Optical Performance**

Beam Angle : 15° / 25° / 40°  
 (8° / 10°x60° - On Request)

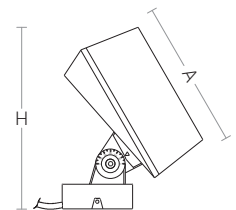

**Ordering Guide**

ID	System Wattage	Dimension (A x H)
22580	15W	Ø130 x 177
22582	30W	Ø170 x 218
22583	60W	Ø210 x 258
22579	72W	Ø260 x 310

