

Inground Luminaire - Microled / Miniled

Installation, Use and Maintenance Guidelines
(Indicative for all luminaires in this series)



Application

Microled and Miniled are tiny IP65 LED fitting suitable for down light, wall recessed and walkover for both indoor & outdoor application. Small dimension with flush mounting installation. It is equipped with a screwless round front ring in STAINLESS STEEL with transparent or opal diffuser. These fixtures are perfect for creating very defined effects of accent light.



Note : Technical amendments reserved

Light Source : LED

Normal rated voltage for luminaire is 220-240V, 50Hz, single phase ac (non-integral), requires suitable power supply.

Installation Recommendation

- This product is suitable for Indoor & Outdoor application.
- The main material of this product is stainless steel, suitable for natural environment, don't install this product near sea water or in the environment which is high in salt or acid content.
- Electronic equipment is sensitive to voltage surges. Hence it is recommended to install a stabilizer at source to ensure constant voltage power supply to all outdoor luminaires, for better performance and life span of the luminaire and to avoid risk of damage.
- Installation and maintenance of the luminaire should be carried out by qualified person only in accordance with good electrical practice and appropriate accessories.
- Use flexible cable of suitable rating and diameter with the right IP rated connectors.
- The IP rating of the connector between fixture and main cable must be equal to or greater than the IP rating of the Luminaire.
- It is very important to follow these instructions to, enable the luminaire to be installed correctly. Failure to follow this will void all warranty on the product.
- Please retain installation guidelines for future reference.

Important Note:

We recommend to drain the mounting area to ensure no water logging at all times, also considering durations of heavy downpour.

Technical Specifications

- Luminaire body and screwless front ring made from solid billet of stainless steel.

- Silicone seal gasket.
- Transparent or opal acrylic diffuser.
- Clear polycarbonate optical lens.
- Luminaire hard wired with 2 × 0.5mm² cable of 1.5mts length.
- Supplied with mounting sleeve for preparing recessed opening in ground or wall.
- Safety class I / III.
- Protection class IP65
- CE - Conformity mark
- Suitable for operation on 220-240V, 50Hz single phase ac (non-integral), requires suitable power supply.
- Available in Green / Blue / Amber / red (On Request).

Light distribution

Luminaire photometric data / IES files for the light planning program DIALux can be downloaded in IES-format on the KLITE web page www.klite.in.

Safety

- For Safety, always ensure power supply is disconnected before regular maintenance, lamp replacement and accessory fitting.
- Installation and operation of this luminaire are subject to national safety regulations. The manufacturer is discharged from liability when damage is caused by improper use or installation.
- Any modification to this fixture without authorization will void all warranty and the persons responsible for the modification shall be considered as manufacturer.
- Observe precautions for handling LED module.
- Do not subject the product for voltage or current which is not rated for.
- Luminaire is not suitable for installation near sea water or in the environment which is high in salt or acid content.

Installation

- Always prepare 20-30cm of drainage gravel and check that it works. Pour a mug of water and check that it completely disappear within 30min. If it doesn't work refine the drainage system further.
- The luminaire must not permanently get in contact with aggressive media that might corrode the housing of the luminaire
- Dismantle luminaire from the recess plastic housing.
- Position recess plastic housing into the floor and fix it using suitable fixing material.
- 0.1m of cable must be left in the installation housing for lifting the luminaire for maintenance and refixing
- For the tightness of the luminaire it is important that the ground surface prepared later is either on the same level or slightly below top edge of the recess housing
- Use appropriate cable with respect to the rating & gland size and fully tightened to avoid ingress of water. The connection provided by the customer must be carried out in the corresponding protection class of the luminaire.
- Never cover visible parts of the luminaires. Any part not protected by the recessing box, must not be in direct contact with the ground or in contact with aggressive chemical elements.
- LED lights work at constant current. When choosing a power supply unit, you need to consider the current by which the LEDs are driven and their maximum power consumption.
- Please ensure that the wires are connected to the right polarity [Phase, Neutral & Earth] for multiple connection / [Phase, Neutral] for single connection and the luminaire must be earthed (Class I).
- Only power up the system once all the lamps are connected. Connecting an individual lamp to an active power supply may cause the lamp to break due to over voltage.
- Only use power cables with an outer sheath. Do not use individual wires in input. Only use flexible cables in rubber with an appropriate diameter. Do not use rigid cables and / or ones with metal core insulation.
- Do not cut the cable provided close to the fixture.
- Insert the luminaire housing into the recess plastic housing.

Important Note :

- LEDs are highly sensitive electronic components. Please avoid touching the light source directly, during installation.
- If fixture is supplied with integrated LED module, **Do Not Open** the front plate of luminaire during installation. Warranty void if the LED compartment is opened.

Cleaning and care

- After installation, the luminaire should first be cleaned.
- Building dust, residues from pressure-sensitive adhesives, paint splatter and rust film must be completely removed. Never use cleaning implements made of normal steel, steel brushes or steel wool because they cause extraneous rust to form.
- Cleaning agents containing hydrochloric acid and chlorides should never be used.
- We recommend cleaning the luminaires regularly.
- Do not use high pressure cleaners

Maintenance Recommendations

The LED module contained in this luminaire shall only be replaced as per the manufacturer recommendation. For further informations, please contact your supplier.

Storage

If site is not ready for installation, store the material in proper warehouse facilities. K-Lite is not responsible for the damages caused due to the mishandling of material at site.



Important Note

To ensure proper installation, kindly translate / communicate the installation instructions to the local qualified electrician in their respective local language.



Please Recycle

The electronic components of this product should not be disposed via the normal waste system. To prevent possible harm to the environment and Human health please ensure that the product is recycled in an environmentally sound manner. Please contact your local collection facilities for more details

Customer Service

If Klite agrees to receive back some fixtures for Lab Testing and further analysis please ensure that the fixtures shipped should NOT BE DISASSEMBLED. Disconnect the power line and ship the product as is unless otherwise specified. Please contact customercare@klite.in for more information.

In-Ground Luminaires

Installation Guidelines

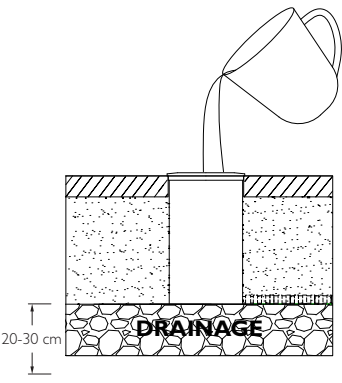

20-30 cm
DRAINAGE

- Always prepare 20-30cm of drainage gravel and check that it works. Pour a mug of water and check that it completely disappears within 30min. If it doesn't work refine the drainage system further.

OK

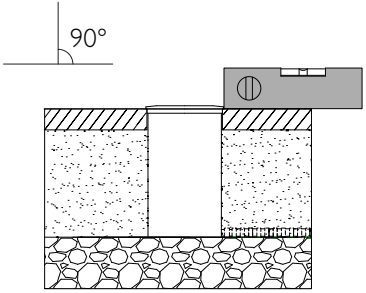

90°

Correct Installation

- Position recess plastic housing into the floor and fix it using suitable fixing material.
- For the tightness of the luminaire it is important that the ground surface prepared later is either on the same level or slightly below top edge of the recess housing.

NO

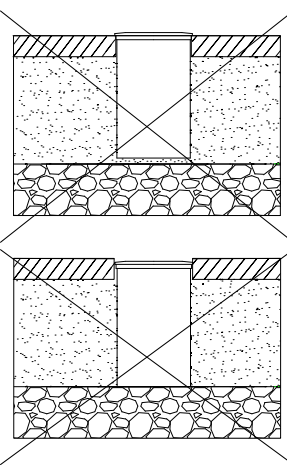

Plastic housing installed into the floor should not be above or below the floor level.

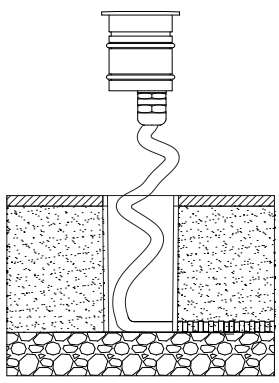

- Use flexible cable of suitable rating and diameter with the right IP rated connectors.
- The IP rating of the connector between fixture and main cable must be equal to or greater than the IP rating of the Luminaire.

NO

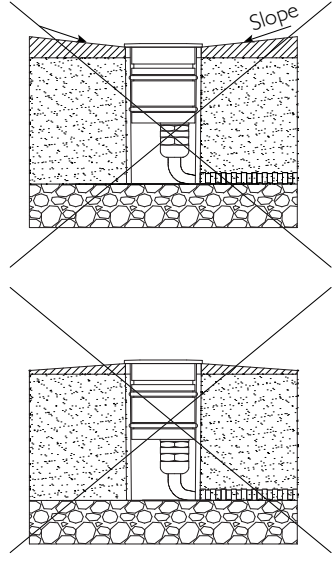

Slope

OK

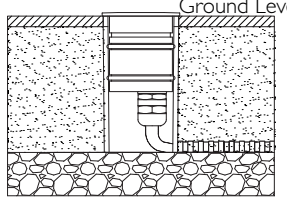

Ground Level

- Please ensure that the wires are connected to the right polarity and the luminaire must be earthed (Class I).
- Insert the luminaire housing into the recess plastic housing, align it and tighten screws firmly.

NO

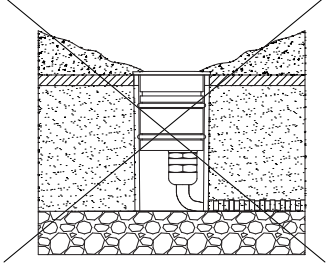

- Never cover visible parts of the luminaires. Any part not protected by the recessing box, must not be in direct contact with the ground or in contact with aggressive chemical elements

Connectors

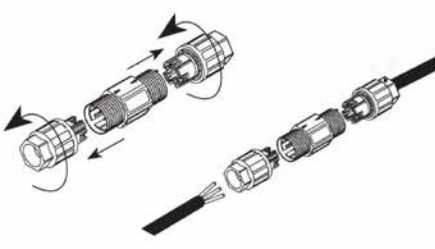

How to Install your outdoor luminaire correctly with connectors



Water infiltration is one of the biggest reasons of damage to outdoors fixtures. The main reason being no proper water proof connectors being used during installation.

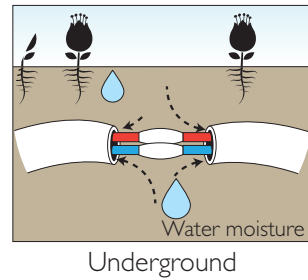
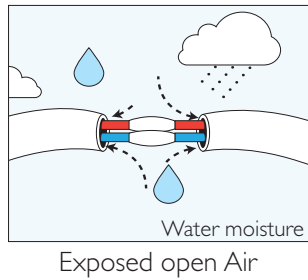

Why use the water - proof connector ?

When the fixture is turned on, the inside temperature will increase as the operating time goes. Conversely when the lamp stops working, the temperature will drop slowly. This phenomenon will cause "The siphon effect". Thermal expansion and contraction makes the inside and outside air pressure different. The air which includes water vapour will infiltrate to the housing through the wire entry as soon as the internal air pressure is lesser than the external pressure. The infiltration is caused by several incorrect connections like the picture below. This water vapour will then become droplets of water that will be seen inside the fixture.

Incorrect Installation

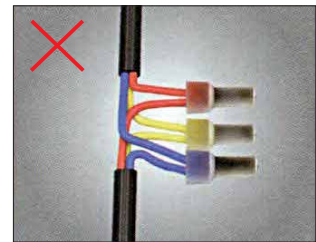
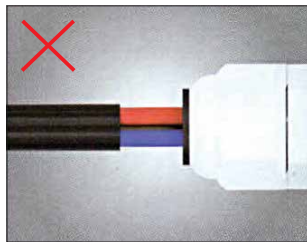

When the wire is connected into the fixture through cable gland, the cable must be more than 10mm inside. Please refer to the images below.

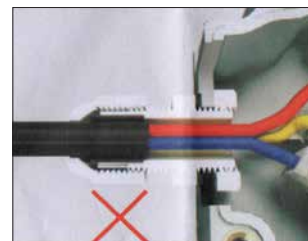
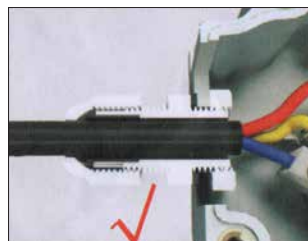

The best and easiest ways to prevent the water filtration are by IP rated connectors

We recommend using the water-proof connectors as shown below for all outdoor fixtures. Installers should prepare the appropriate main cables of suitable rating and diameter with the right IP rated connectors.



Two Way Connector



Three Way Connector



One input & two output

